

FIMER

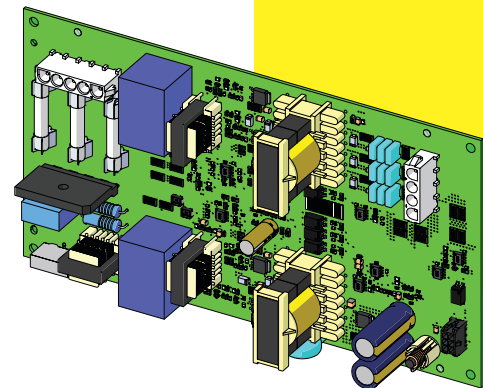

Solar Inverter PVS-100/120 PRE-CHARGE BOARD KIT

Quick Installation Guide

1. Functionalities

Pre-charge board allows to recharge PVS-100/120-TL (B2 version) internal bulk capacitors from AC grid side: so doing, inverter is able to connect to the grid even during night-time when no DC voltage is available from PV panels side. The main advantage related to this feature is the possibility to realize night reactive power production when it is desired, i.e. night-reactive power on-demand. Most common examples of nightreactive power on-demand are:

- Night-time reactive power demand after inverter disconnection;
- Recovery from AC grid disconnection during night-reactive power;
- Round scheme night-reactive power.

Inverters with pre-charge board are also able to satisfy immediately to request of night reactive power that arrives during the night with the AC grid interface contactors opened, since this board provides the capability to restore the grid connection.

Pre-charge board can also provide the possibility to reestablish normal operation when a grid fault causes disconnection of the inverter. For example, during night time, when inverter is in night reactive power mode, if AC voltage dip occurs, inverter disconnects from the grid. For inverter with precharge board installed, night reactive power can be reestablished also after grid dips.

⚠ WARNING – Risk of electric shock. Hazardous DC voltages are supplied to the photovoltaic array during the night.

2. Main components

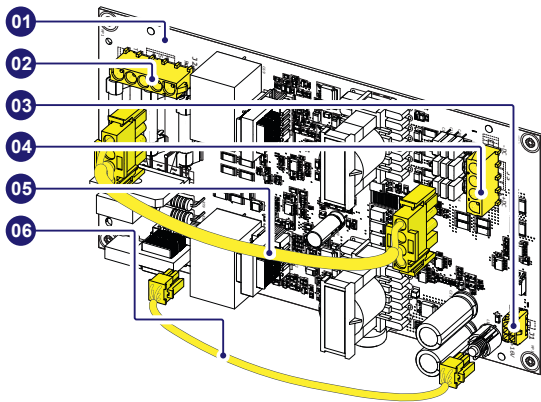

Main components

- | | |
|----|-----------------------------|
| 01 | Pre-charge board |
| 02 | AC grid voltage connector |
| 03 | Auxiliary voltage connector |
| 04 | DC voltage connector |
| 05 | DC voltage wiring |
| 06 | Auxiliary voltage wiring |

3. Supplied component list

Components available in the kit

Quantity

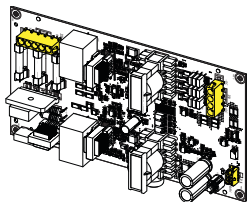

Pre-charge board

1



DC voltage wiring (05)

1



Auxiliary voltage wiring (06)

1



M4x14 screws for mechanically securing the grounding board to the wiring box

4

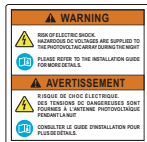

Warning label

3



Technical documentation

1

4. Assembly instructions

⚠ WARNING – Access to the zones inside the inverter must be carried out with the equipment disconnected from the network and from the photovoltaic generator. Perform the "Inverter total de-energization and safe access" procedure described in the inverter product manual.

The PVS-100/120 PRE-CHARGE BOARD KIT must be installed inside the wiring box.

4.1 Opening the wiring box cover

• Perform the "Inverter total de-energization and safe access" procedure described in the inverter product manual.

• Use the key tool (provided with the installation kit contained in the wiring box package) to open the three cover quarter cam locks (05) following the proper rotation as shown in the related silkscreens on the wiring box cover (07).

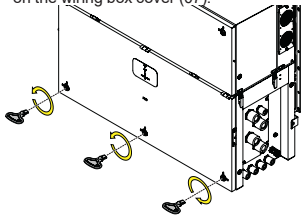

• Open the wiring box cover (07) and use the cover support brackets (14) to lock the cover (07) in open position.

⚠ ATTENTION – Pay attention to properly secure the cover support brackets (14) in order to avoid falling of the cover!

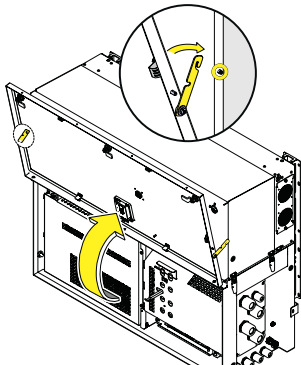

4.2 Access to the Pre-charge board

In order to allow access to the precharge board, preliminary operations are necessary which differ according to the wiring box version.

4.2.1 Preliminary installation operation on 1/2 MPPTs wiring box:

• Remove the internal DC Protective shields (60) by removing the six M5 screws. Remove firstly the lower shield (in yellow) and the upper one after (in green).

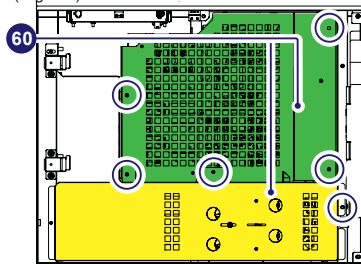

4.2.2 Preliminary installation operation on 6 MPPTs wiring box:

• Remove the internal DC Protective shield (60) (in yellow) by removing the two M5 screws.

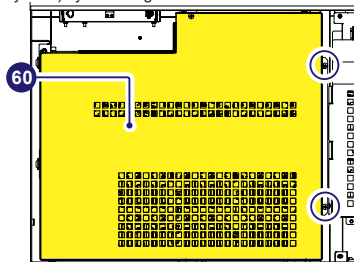

- Remove the 4 locking screws of the fuse boards panel.

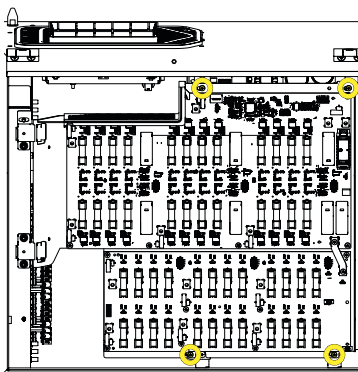

- Open (pull) the fuse boards panel.



4.3 Pre-charge board installation

At the end of preliminary installation operation, the area where the pre-charge board (01) is accessible.

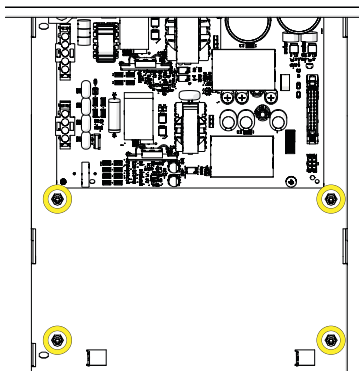

- Install the pre-charge board (01) on the 4 standoffs and lock it using the four M4 screws (supplied in the kit).

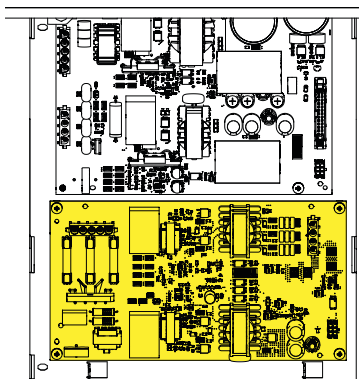

- Connect the DC voltage wiring (05) :
 - one side on the DC voltage connector (04) of the pre-charge board (01).
 - other side on J2 of the board near to the pre-charge board (01).

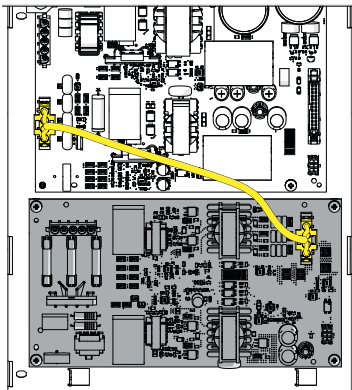

- Connect the AC grid voltage wiring :
The AC grid voltage wiring is pre-installed inside the wiring box (near to the pre-charge board (01) installation area) and must be connected to AC grid voltage connector (02) of the pre-charge board (01).

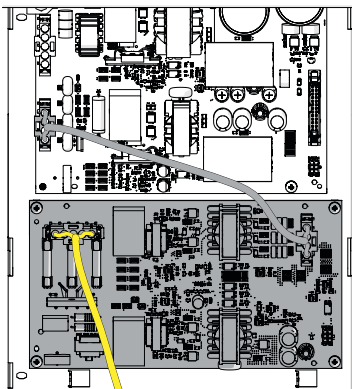

- Connect the Auxiliary voltage wiring (06) :
 - one side on the Auxiliary voltage connector (03) of the pre-charge board (01).
 - other side on J1 of the board near to the pre-charge board (01).

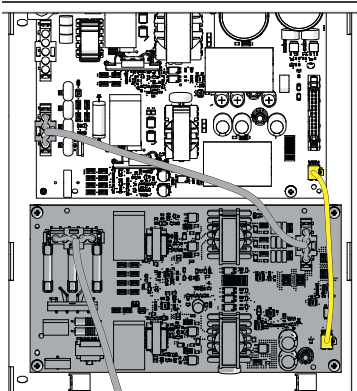

- At the end of installation reinstall:
 - the fuse boards panel by screwing the 4 screw previously removed
 - the DC protective shields (60)
- Close the wiring box cover (07).
- Stick the label supplied with the kit near to the certification label of the wiring box:

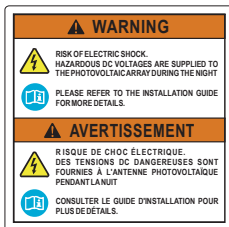

5. Commissioning

Perform the following procedure (described in the product manual of the inverter) in order to commissioning the inverter.

- Close the DC disconnect switches (15) to supply the inverter with input voltage from the photovoltaic generator

- Close the AC switch downstream of the inverter (and AC disconnect switch (09) in the version of wiring box where is present).

- When the input voltage is sufficient to allow the connection to the grid, the inverter will check the grid voltage, measure the isolation resistance of the photovoltaic field with respect to ground and performs other auto-diagnostic checks. During the preliminary checks on the parallel connection with the grid, the "Power" LED keeps flashing, the "Alarm" and "GFI" LEDs are OFF. The inverter will ONLY connect to the grid if all parameters fall within the ranges foreseen by current regulations.

- If the outcome of the preliminary checks to grid synchronization are positive, the inverter connects and starts to export power to the grid. The "Power" LED remains fixed on while the "Alarm" and "GFI" LEDs are OFF.

- To access to the Web User Interface is required to connect a device equipped with wireless connection (such as tablet, laptop or smartphone). Enable the wireless connection on the device (tablet, smartphone or laptop) and connect it to the Access Point created by the inverter system: the name of the wireless network created by the inverter that the connection should be established with, will be: ABB-XX-XX-XX-XX-XX-XX where "X" is a hex digit of the MAC address (MAC address can be found on the "Communication Identification label" placed on the side of the inverter or applied during the commissioning phase to the plant documentation).

- When required digit the PRODUCT KEY (printed on the "Communication Identification label" and applied during the commissioning phase to the plant documentation) as access point password.

NOTE – It's required to digit also the dash "-" characters of the Product Key in the password field.

NOTE – In case of need, product key can be recovered by Aurora Vision Cloud or by calling Fimer technical support.

- Open an internet browser (reccomended browser: Chrome versions from v.55, Firefox versions from v.50) and enter the pre-set IP address 192.168.117.1 to access the login page.

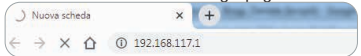

- Enter the Menu "Setting/Additional Function".

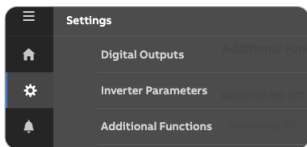

- Set as ENABLED the Pre-charge Kit (if is installed as an accessory on the field) with the proper selector.

Additional Functions

NIGHT MODE	
Pre-Charge Kit	enabled <input type="checkbox"/>
Night Mode Status	running
S max [VA]	120000
Night Q Fix Set-point [%Smax]	0 <input type="text"/> <input type="button" value="Save"/>
Night Reactive Power Mode	DISABLED <input type="button" value="Save"/>

NOTE – The "Night Modes Status" will indicate the state of functioning of the board.

By dedicated Web User Interface (UI), night-time reactive (Q -fix Mode or Volt/Var Mode) power can be enabled or disabled and night-reactive power mode and set-point can be modified.

Thanks to smart microcontroller supervision, when night comes, i.e. input voltage falls below disconnection threshold, inverter enters automatically night mode seamlessly: thus AC disconnection doesn't occur in this case and inverter passes immediately from day to night operation.

- The field "Night Q Fix Set-point [%Smax]" allows to set the reactive power value indicated as percentage of Smax value (the maximum value of S [VA] is indicated on the field Smax).

Additional Functions

NIGHT MODE

Pre-Charge Kit	enabled	<input type="checkbox"/>
Night Mode Status	running	
S max [VA]	120000	
Night Q Fix Set-point [%Smax]	0	Save
Night Reactive Power Mode	DISABLED	Save

- The field "Night Reactive Power Mode" allows to set the functionality mode of reactive power injection.

Additional Functions

NIGHT MODE

Pre-Charge Kit	disabled	<input type="checkbox"/>
Night Mode Status	not running	
S max [VA]	120000	
Night Q Fix Set-point [%Smax]	DISABLED Q Fix	Save
Night Reactive Power Mode	✓ Volt/Var: Q(V)	Save

- DISABLED:** no reactive management at night
- Q Fix:** injection of a fixed amount of reactive power delivered only during the night. The quantity of reactive is determined by the relative set point (field "Night Q Fix Set-point [%Smax]")
- Volt/Var:** activation of the Volt-Var grid voltage regulation mode even during the night with the same characteristics and modes defined in the Volt-Var section (daytime behavior).

⚠ ATTENTION – For external control systems it is recommended to enable the Q-Fix reactive mode with management of the reactive power set point as during daytime operation.

FIMER_PVS-100_120 PRE-CHARGE BOARD KIT_Quick Installation Guide_EN_RevA 09-09-2020



For more information please contact your local FIMER representative or visit:

fimer.com

We reserve the right to make technical changes or modify the contents of this document without prior notice. With regard to purchase orders, the agreed particulars shall prevail. FIMER does not accept any responsibility whatsoever for potential errors or possible lack of information in this document.

We reserve all rights in this document and in the subject matter and illustrations contained therein. Any reproduction, disclosure to third parties or utilization of its contents – in whole or in parts – is forbidden without prior written consent of FIMER. Copyright© 2020 FIMER. All rights reserved.